

JUNONA

line

kuchnie dla każdego

BLACK RED WHITE 

NOWOŚĆ



JUNONA *line*

4 wersje kolorystyczne

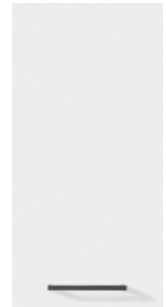
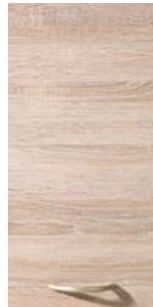

1

dąb sonoma
/ dąb wenge

2

dąb
sonoma

3

modrzew
sibiu jasny

4

biały połysk /
szary wolfram

komplet 240
modrzew sibiu jasny
oraz półka podświetlana



Kupując komplet oszczędzasz!

Komplet **Junona Line 240** i **mikroukład 150** i **100** zostały stworzone z myślą o jak najniższych cenach. Zakup całego kompletu jest bardziej ekonomiczny, niż elementów kupowanych osobno. W skład kompletu wchodzi szafki niezbędne do Twojej kuchni, które można rozbudować o dodatkowe elementy.

mikroukład

150

3 moduły

549 pln

elementy do
rozbudowy

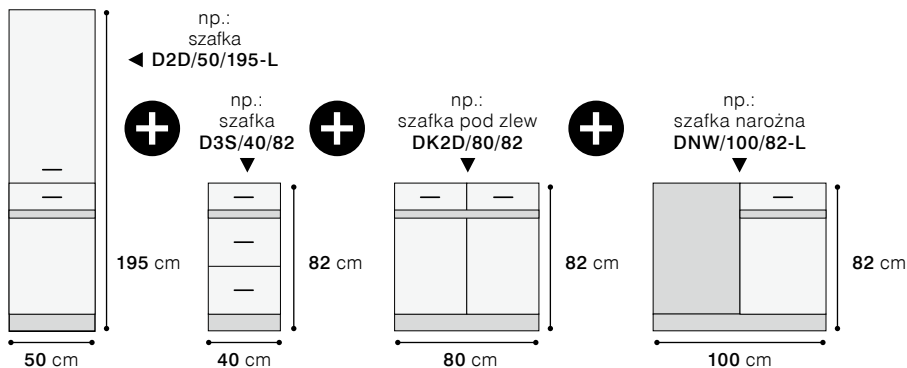
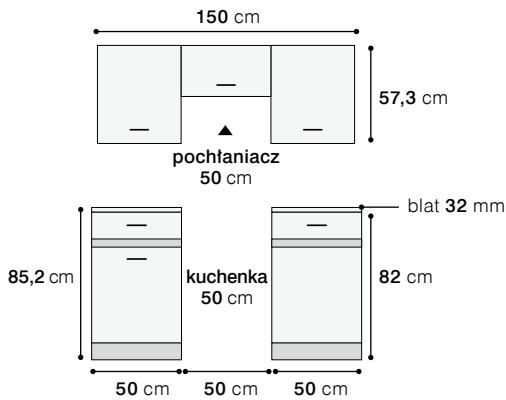

wszystkie elementy do rozbudowy znajdziesz na str. 15



przykładowa aranżacja:
mikroukład 150 + D2D/50/195-L, D3S/40/82,
DK2D/80/82, DNW/100/82-L
biały połysk / szary wolfram

NOWOŚĆ

Kupując komplet oszczędzasz!

komplet
240

7 modułów

899 pln

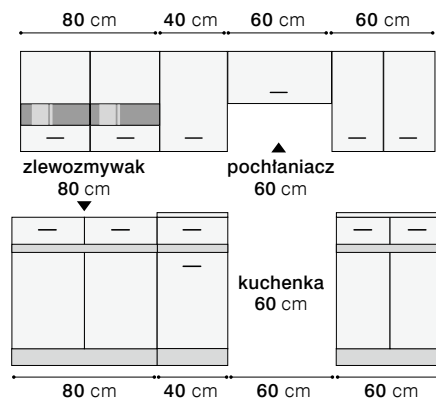

Na komplet 240 składa się 7 modułów,
które można dowolnie ustawiać.



wszystkie elementy
do rozbudowy
znajdziesz na str. 15



komplet 240
dąb sonoma / dąb wenge



mikroukład

150

+ elementy do
rozbudowy

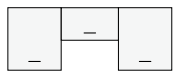

150 cm



80 cm

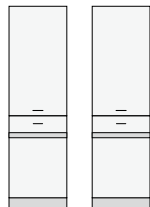

50 cm



50 cm

+ wszystkie elementy
do rozbudowy
znajdziesz na str. 15



wersja
kolorystyczna

1

dąb sonoma
/ dąb wenge

fronty górne: **dąb sonoma**
fronty dolne: **dąb wenge**
(wstawka - **dąb sonoma**)
korpusy: **dąb wenge**
blaty 32 mm: **dąb sonoma**



mikroukład 150

+ szafki: DK2D/80/82, G2W/80/57, D2D/50/195-L, D2D/50/195-P
dąb sonoma / dąb wenge
oraz półka podświetlana





stół kuchenny z ławkami w opcji



półka podwieszana dostępna w kolorach:
dąb wenge i **biały** (o szer. 40, 50 lub 100 cm),
półka szklana z oświetleniem **LED** w opcji

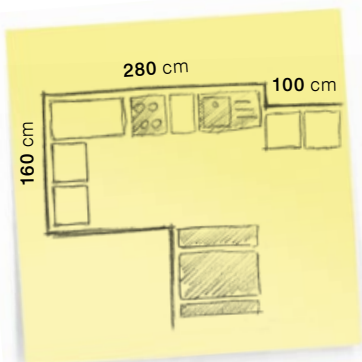

+ wszystkie elementy
do rozbudowy
znajdziesz na str. 15

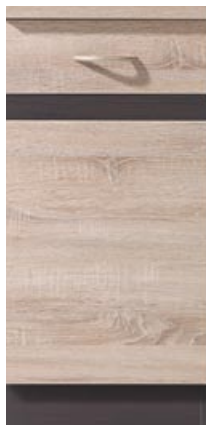

wersja
kolorystyczna

2

dąb sonoma

fronty górne: **dąb sonoma**
fronty dolne: **dąb sonoma**
(wstawka - **dąb wenge**)
korpusy: **dąb wenge**
blaty 32 mm: **dąb sonoma**



przykładowa aranżacja
zastosowane szafki: **D2D/50/195-P, D2D/50/195-L,**
DK2D/80/82, G2W/80/57, D3S/40/82, G1D/40/57,
DPK/60/82, DNW/100/82, G1D/50/57, G1D/50/57,
D1D/50/82, D1D/50/82
dąb sonoma





oświetlenie dodatkowe

wersja
kolorystyczna

3

modrzew sibi jasny

fronty górne: **modrzew sibi jasny**
 fronty dolne: **modrzew sibi jasny**
 (wstawka: **sosna larico**)
 korpusy: **biały**
 blat 32 mm: **incanto**

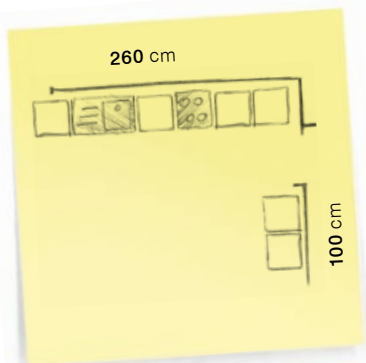

wszystkie elementy
do rozbudowy
znajdziesz na str. 15

**mikroukład**

100

**elementy do
rozbudowy**

100 cm



40 cm

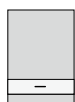

40 cm

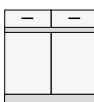

80 cm



przykładowa aranżacja:
 mikroukład 100 + D1D/40/82-P, D3S/40/82, G2W/80/57,
 DPK/60/82, GO/60/30, D3S/40/82, G1D/40/57-LP,
 DK2D/80/82, G2D/80/57 oraz półka podświetlana

NOWOŚĆ



mikroukład 150
biały połysk / szary wolfram

wersja
kolorystyczna

4

biały połysk/ szary wolfram

fronty górne: **biały połysk**
fronty dolne: **szary wolfram**
(wstawka: **biały połysk**)
korpusy: **biały**
blat 32 mm: **incanto**



mikroukład
150

mikroukład
100

G2D/80/57

G2W/80/57

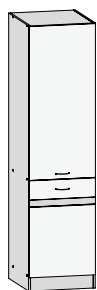

D2D/50/195-L



D2D/50/195-P

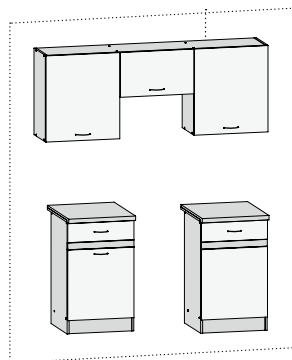

DG4D1S1K/150*

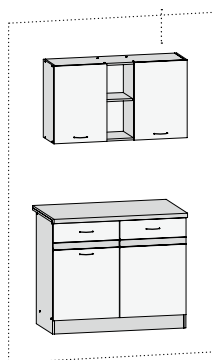

DG4D1S/100*

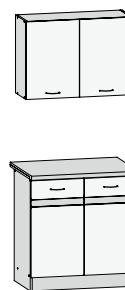

D2D/80/82

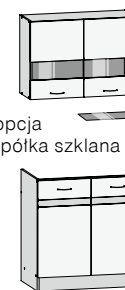

DK2D/80/82

G2W/80/57
OPCJA

opcja
(półka szklana + oświetlenie)



G2D/60/57



G1D/40/57-LP



G1D/50/57-LP



GO/50/30



GO/60/30



POL/40



POL/50

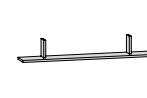

POL/100

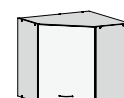

GNWU/57-LP

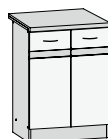

D2D/60/82

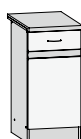

D1D/40/82-L



D1D/40/82-P



D3S/40/82

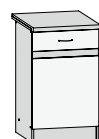

D1D/50/82-L

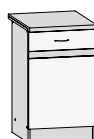

D1D/50/82-P

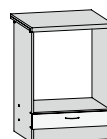

DPK/60/82



DNW/100/82-L



DNW/100/82-P



elementy do rozbudowy

- wszystkie szafki dolne wyposażone są w blat z wyjątkiem DK2D/80/82
- wszystkie fronty posiadają uchwyty:
- dąb sonoma, dąb sonoma/dąb wenge - uchwyt w kolorze satyna o rozstawie 96 mm
- modrzew sibiu jasny, biały połysk/szary wolfram uchwyt w kolorze tytan o rozstawie 128 mm

* sprzedaż tylko
w komplecie

- wys. szafek górnych 57,3 cm
- wys. szafek dolnych 82 cm + blat 32 mm
- gł. szafek dolnych: 45,3 mm
- gł. szafek górnych: 28,8 mm

kuchnie dla każdego

JUNONA *line*

1 komplet

2 mikroukłady



20 modułów

wszystko

w 4 wersjach
kolorystycznych

